

NEW JCB NXT 205 / 205Lc | THE NXT LEVEL



Engine Power : 104 KW (140 hp), Bucket Capacity : 0.9 cu.m GP / 0.9 cu.m (HD)
Operating Weight : 20,500 Kg (SC) / 21,250 Kg (LC)



JCB NXT 205

THE NXT LEVEL

NXT LEVEL OF RELIABILITY

NXT LEVEL OF INTELLIGENCE

NXT LEVEL OF FUEL EFFICIENCY

NXT LEVEL OF CONNECT

NXT LEVEL OF MAINTENANCE

NXT LEVEL OF SAFETY





NXT LEVEL OF FUEL EFFICIENCY

Class-leading fuel efficiency with energy saving **ecoHydraulics**, offering more savings.



Innovative power management to minimise losses:

- Fuel consumption reduced up to 32%* in eco mode



Optimises engine and hydraulic power to maximise savings.

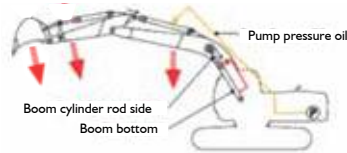

Boom, arm and bucket regeneration for faster operation and fuel saving.



Control valve with in-built flow summation for fast & efficient combined operations.

NXT LEVEL OF INTELLIGENCE

JCB presents an advanced excavation solution **IntelliControl** which optimises machine performance for output and fuel efficiency as well as it displays all key operating, maintenance and health related parameters on a large 7 inch LCD display leading to ease of machine usage.



First & largest in segment:
7 inch colour LCD screen



Dial type throttle



Quantity of fuel left (in litres)

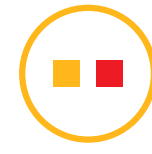

Colour coded health alerts based on severity



Engine speed & operating mode status



Next service due information



Hammer over use indication



Rear view camera option

*T&C Apply.

NXT LEVEL OF CONNECT

Now be assured of your JCB excavator's service, operation and security with the advanced telematics system called the LiveLink with a host of new additional features.



Stay connected 24x7



Sudden fuel level drop alert



Fuel level monitoring



Idle time monitoring



Engine long idling count



Mode-wise breakup for machine usage



Hot engine shut down report





NXT LEVEL OF RELIABILITY

Reinforced structure made for longer life in tough strata.

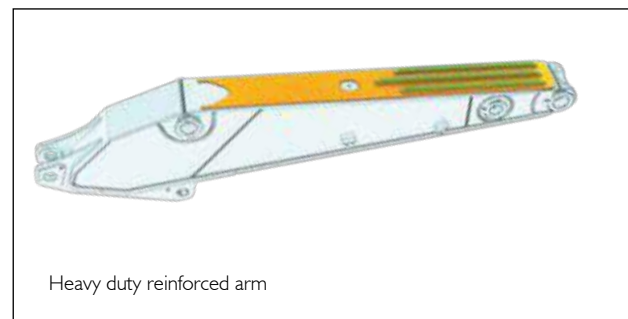
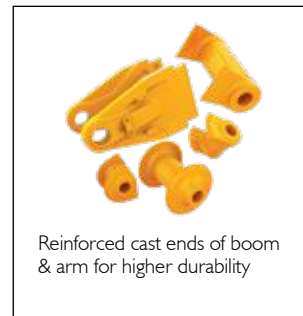
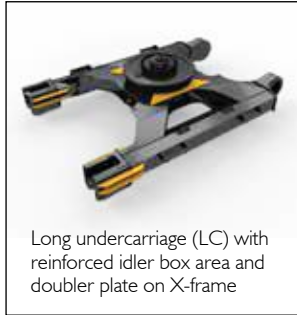

NXT LEVEL OF MAINTENANCE

Best-in-class service interval.

Service intervals on bucket operation	
Hydraulic oil	Every 5,000 hours
Hydraulic oil filters	Every 1,000 hours



Graphite infused bush for 1000 hours greasing at boom ends

Class-leading maintenance interval



Critical health alerts

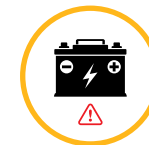

Battery disconnect switch



Service due reminder



Radial seal air filter

First-in-class safety features



2 Go system



Selectable swing lock



hydraulic accumulator

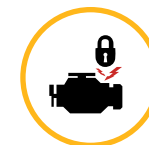

Hydraulic inter lock to start engine



Engine & hydraulic overheat safety system

FABRICATION

- 1 High precision laser cutting technology is only used by JCB in the industry for excavator parts. This cutting-edge technology provides accurate profile cut parts, delivers stronger structures.
- 2 JCB is the first in the industry to use a bevel cutting robot, which gives an accuracy of 0.1mm to the parts, thereby ensuring best weld joints and strength to each component.
- 3 JCB uses the unique flattening rollers for 9-roll straightening process which makes the parts straight within 0.1mm. This ensures accuracy of manufacturing for excellent strength leading to stronger component.
- 4 The high precision CNC press bending used by JCB ensures reliability of the parts. This process delivers high precision and accurate bending of parts making them high quality and reliable, JCB has the biggest capacity for press brakes in India to deliver long parts without joints.
- 5 The unique hydraulic Jigs make every JCB part reliable, accurate and repeatable. The pre-defined control points in this machine give every part the desired accuracy and avoid any manual intervention.
- 6 JCB uses the latest vision system in the robotic welding to weld 100% parts of the excavators. This unique addition to the conventional robotic welding ensures precise weld position thereby, giving perfect structures for the excavators.
- 7 The state-of-the-art duplex boring machine is used for the final process that ensures critical dimensions within 10 microns hence improving the quality of the assembly.
- 8 FARO dimensional Inspection is the latest technology used by JCB for quality assurance. This machine can measure the parts in few microns ensuring best-in-class machine components.
- 9 Ultra-sonic weld Inspection, the process being used only by JCB ensures zero defect in welding. This process checks internal weld integrity. 100% of the JCB parts go through this test.
- 10 Bolstering JCB's promise of zero defect machine, is the pre-dispatch inspection. JCB experts carry out the PDI checks and other functional tests of each and every fabrication before assembly, thus making sure there is no fault forward.

**NO FAULT
FORWARD**

made in **INDIA**
for the **WORLD**





NXT LEVEL OF RELIABILITY

STRENGTH INSIDE AND OUTSIDE.

Your most reliable partner

- 1 The heavy-duty boom uses deep section design and pivot ends made of cast steel for higher strength. The durability of the boom has been further enhanced with strengthened foot box section and increased weld strength on cylinder pivot section.
- 2 The heavy-duty upper frame has reinforced boom mounting area and offers closed box section design on side frame for high durability for tough working conditions.
- 3 JCB NXT 205 comes with heavy duty track link for long life thus reducing the maintenance cost and boosting machine uptime.
- 4 The JCB NXT 205 comes with a reinforced arm with a full-length additional plate to enhance strength for high durability. Wear ribs are provided for damage protection in an arduous working environment.
- 5 JCB NXT 205 offers Heavy Duty X-frame design of track frame. LC version is available with strengthened idler area and doubler plates on X frame for enhanced strength. The heavy duty track link assembly extends life and reduces maintenance cost.
- 6 The JCB NXT 205 carries a strong heavy duty bucket - 0.9 cu.m, which is available as an option, designed to achieve easy fill and discharge while enabling a high level of bucket tear out in stone quarry application.



Heavy duty boom

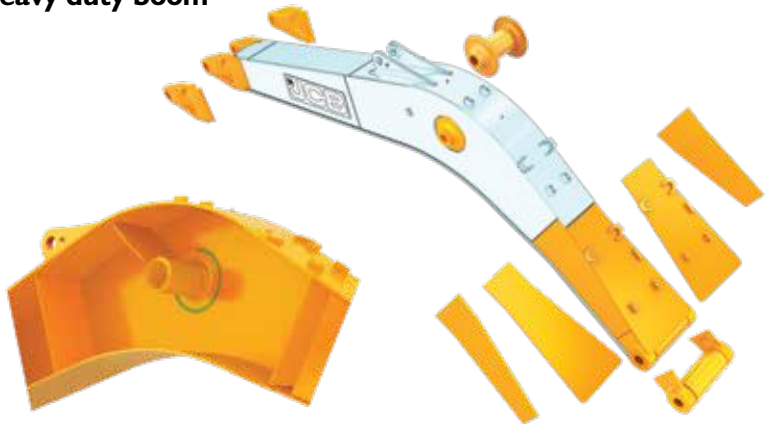

1

Heavy duty upper frame



2

Heavy duty undercarriage



3

Reinforced arm with additional full length strengthening plate at the bottom with wear ribs

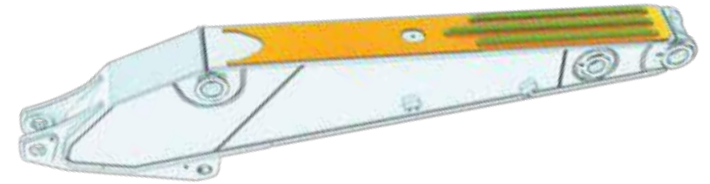

4

Heavy duty X-frame



5

Heavy duty bucket



6



7 The JCB NXT 205 presents proven branded hydraulic components designed and manufactured to achieve long life, ensuring high uptime and reduce life-cycle maintenance costs.

8 The robust fuel filtration system in JCB NXT 205, presents high capacity fuel pre-filter with water separator, eliminates impurities & water from fuel and protects the fuel system, increasing machine uptime and lowering the maintenance cost.

9 New hydraulic return line filter comes with improved filtration efficiency to ensure high cleanliness level of hydraulic system which enhances life of hydraulic components. The rock-breaker piping, if fitted, comprises of a high efficiency rock-breaker return line filter to keep the hydraulic oil clean for long life of hydraulic components. A clog indicator is provided on rock-breaker return line filter to alert for proactive maintenance in case the filter is clogged.

10 The JCB NXT 205 comes with unique dust and water-proof IP67/IP69 connectors with an electrical harness for trouble-free operation and high uptime.

11 The display in the JCB NXT 205 is water and dust proof to provide long life in most demanding working conditions.

Proven branded hydraulic components for more savings to your business



7

Robust fuel filtration system

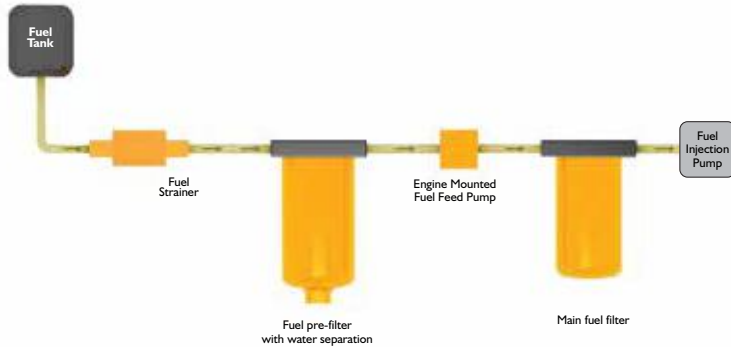

8

IP69 connectors

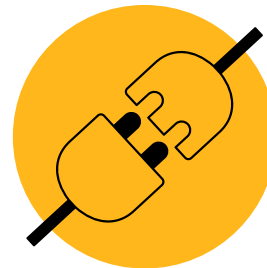

10

Waterproof display



11



NXT LEVEL OF FUEL EFFICIENCY

THE BEST-IN-CLASS EFFICIENCY WITH ENERGY SAVING **ecoHYDRAULICS** OFFERS NXT LEVEL OF SAVINGS.

- 1 JCB NXT 205 comes with best-in-class efficiency, as it is loaded with advanced hydraulic system and optimised pump control. The machinery comes with improved engine speed control and is specifically designed for lower energy consumption ensuring your business with more savings.
- 2 With one touch deceleration system, the JCB NXT 205 boosts your savings, as the unique feature helps to reduce engine rpm by just giving one touch to the switch provided on RH joystick thus reducing fuel consumption.
- 3 The auto idler feature in the JCB NXT 205 automatically reduces engine rpm when the machine is not in use for 4 seconds. Lowering fuel consumption and increasing savings. The **IntelliControl** system enables the user to adjust this auto idle time as per requirement and convenience.
- 4 The JCB NXT 205 comes with a unique attribute, that is a perfect combination of engine power and hydraulic power, helping to save on engine power resulting in leading fuel efficiency, thereby boosting your savings.
- 5 JCB NXT 205 features **ecoHydraulics** which minimise the hydraulic losses resulting in enhance fuel efficiency, thus increasing savings.
- 6 The JCB NXT 205 innovative hydraulic regeneration system recycles hydraulic oil across the cylinders for faster cycle times and reduced fuel consumption.

5



JCB
DYNAMIC
EFFICIENCY

Optimises engine and hydraulic power to maximise savings.





2



3



FUEL SAVINGS UP TO 32% IN ECO MODE

Control valve with in-built flow summation for fast & efficient combined operations.

4

Regenerative hydraulic system

Pump pressure oil

Boom cylinder rod side
boom bottom

Regenerative circuits for higher operating speeds

5

*Results shown are based on internal trials done in standard test conditions. they may vary on basis of operator efficiency and type of application

NXT LEVEL OF PRODUCTIVITY

1 With ability to work in demanding conditions, the JCB NXT 205 has excellent bucket digging force and dipper tear-out forces, resulting in higher output and faster completion of work, especially in hard strata. The optimised hydraulics ensure high productivity and more savings to your business, as it helps in faster multi-function performance leading to high output and low energy consumption.

2 The JCB NXT 205 comes loaded with 3 Power modes - eco, Power & Power plus. These 3 user friendly power modes enable the operator to choose right machine working parameters as per the site condition & application, resulting in ease of work, faster job completion and enhanced productivity, keeping your business an edge ahead.



1



Power mode		Usage for
P+	Power plus	For maximum output Suitable for high output in heavy duty strata
P	Power	For high output needs
eco	Economy	For general duty operations & low fuel consumption



2





3 The JCB NXT 205 comes with options of bucket for a range of applications. These buckets are designed for efficient digging, easy fill and discharge of materials, thus resulting in increased earnings.

4 With high pressure settings, the JCB NXT 205 gets more power for doing extra work even in hard strata, ensuring high productivity.

5 Faster swing speed of 13 rpm with swing torque of 65.2 kNm helps to complete the digging cycle in a minimum time & increases overall productivity of the machine.

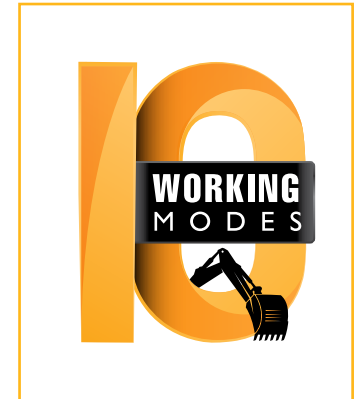

*T&C Apply.

NXT LEVEL OF COMFORT

A COMFORTABLE OPERATOR IS A PRODUCTIVE OPERATOR.

- 1 Best-in-class 7 inch digital colour monitor displays operational & maintenance parameters to keep the operator updated on the machine status. It displays power modes, working hours including attachment selection, trip hours, real-time fuel quantity and host of other information so that the operator can maximise machine output & uptime.
- 2 Thin and low effort joystick ensures fatigue-free operation for longer hours.
- 3 Easy to use rotary switch controls the engine speed and power modes selection as per the job requirement.
- 4 The fuel refilling pump option in JCB NXT 205 ensures customers with time and manpower savings with auto stop features for hassle free fuel refills.
- 5 The large sized mirrors in JCB NXT 205 ensure more machine safety and hassle-free operator working condition. The wiper wash in JCB NXT 205 is provided for better front glass visibility.
- 6 Easy to open roof hatch assisted with 2 gas struts helps to keep the cab well ventilated. Higher visibility and safe operations with front top corner glass.
- 7 The JCB NXT 205 comes with unique linkage arrangement for front glass lifting leading to effort and time saving, and large RH glass for excellent visibility.



1



5



6



2

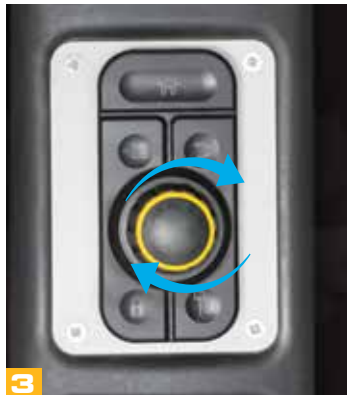

3

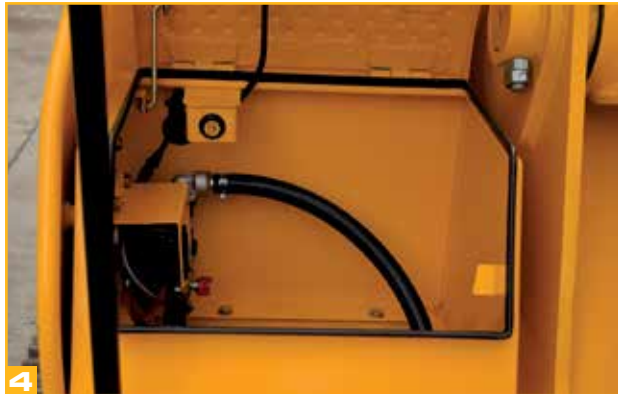

4



7



8 5 working lights 2 on the cab front top, 1 on boom's left side, 1 in tool box and 1 on counter weight, provide better illumination and help the operator to work efficiently even at night.

9 Wide and rubber coated footrests provide excellent grip and excellent travel control.

10 The JCB NXT 205 comes with laminated RH and front glass ensuring less breakage adding more life to the glass.

11 HD door locks ensure that side cowlings are always at their position to increase door life.

12 Powerful AC option to cool the cab with the multi-position wind outlet points from the back, front and bottom side.

13 New fully adjustable seat with enhanced backrest support gives excellent comfort to the operator and leads to fatigue-free operation for longer hours.

14 Cab is mounted on 6 nos. viscous mounts to absorb vibration that ensures comfort for the operator.







Introducing IntelliControl on the advanced JCB NXT 205

BECAUSE INTELLIGENCE EMPOWERS

JCB presents an advanced excavation solution that shows you everything you want to see in real-time. The JCB NXT 205 is loaded with IntelliControl, giving you a complete view of the entire operations so that you can optimise your machine's performance and health. Experience intelligence, be empowered.



Best-in-class 7 inch digital anti-glare informative colour display

Operational information



Quantity of fuel left in tank



Engine speed & operating mode status



Trip meter



Auto idle status & time setting



Machine operating parameters



Rear view camera option

Maintenance information



Maintenance due information



Colour coded health alerts based on severity



Hour meter, counting of attachment operation



Easy diagnostic system



Service warning alerts

NXT LEVEL OF MAINTENANCE

THE DESIGN OF JCB NXT 205 ENSURES EASE OF MAINTENANCE AND ALERTS ON DISPLAY WITH WHICH YOU CAN PLAN THE MAINTENANCE IN ADVANCE. GET THE NXT LEVEL OF MORE UPTIME, HIGHER MACHINE UTILISATION AND QUICK SERVICEABILITY.

- 1 Plan your work better with the maintenance reminders on the display, which gives information with regard to the hours left for next service. Refuel your machine on time, as the monitor displays the quantity of fuel left in the tank.
- 2 Advanced self diagnosis system with error codes and multi-coloured warning alerts for easy and quick maintenance.
- 3 Display of all critical parameters, accessed through internal menu for easy health monitoring.
- 4 Independent breaker hour meter indicates the hours for breaker attachment usage, thus helping in maintenance planning.
- 5 Ensure safety of your machine with alerts about high engine coolant temperature, low engine oil pressure, low coolant level, clogged air filter & high hydraulic oil temperature.



5



6



7



8



1

INTELLI
CONTROL

2

3



4

Independent breaker hour meter

- 5 Wire mesh guard on the cooling pack to prevent entry of debris or other objects in cooling pack. It protects the engine & hydraulic system from overheating, thereby providing ease of maintenance as well as higher machine uptime.

Side by side installation of engine radiator and oil cooler offers ease of cleaning while enhancing cooling efficiency of the system.

- 7 The engine bonnet is compact in size and is supported by a gas strut. It helps in easy and effortless handling of the bonnet during maintenance. It also provides the operator high rear end visibility.

- 8 Battery disconnect switch helps to isolate machine's electric system easily whenever required.



NXT LEVEL OF SAVINGS ON MAINTENANCE

THE JCB NXT 205 IS ENGINEERED TO GIVE YOU MORE PROFITS AND LESS MAINTENANCE COST.

THE LONG SERVICE INTERVALS AND HIGH QUALITY PARTS GIVE YOU THE NXT ADVANTAGE OF LOWER DOWNTIME AND HIGHER PROFITS.

1 JCB NXT 205 carries an innovative filtration system that keeps hydraulic oil clean and extends hydraulic maintenance intervals, reducing cost. It reduces inventory as well as saves manpower time. Reduces maintenance cost & increases machine availability for productive work, giving more power to your business.

2 Pre-cleaner comes as standard in JCB NXT 205 ensuring longer air filter life, less maintenance cost & enhanced engine life.

3 Radial seal type air filter elements provide secure and error-free sealing, protect the engine from dust particles keeping it clean, thereby enhancing engine life. In addition, filter elements are covered with wire mesh to avoid damage.

4 Greasing interval of 1000 hrs is achieved with graphite impregnated bronze bushes at boom ends for higher uptime and lower maintenance cost.

SERVICE INTERVALS	
Hydraulic main filter	Every 1,000 hours
Hydraulic oil	Every 5,000 hours

1



By using graphite impregnated bronze bushes, JCB has increased the boom and dipper greasing intervals to 1,000 hours for normal applications.

4



NXT LEVEL OF SAFETY

SAFETY IS PRIMARY FOR JCB WHETHER IT IS OF THE MACHINE OR OF THE OPERATOR THEREBY, SERVING YOU WITH FIRST-IN-CLASS SAFETY PARTS AND FEATURES THAT ALSO ENSURE LOW DOWNTIME AND HIGHER PRODUCTIVITY.

1 Ensure higher uptime & better management of your fleet with an improved advanced telematics system - LiveLink. It helps the owners to know about several aspects of their machines including location tracking, machine utilisation report, machine health alerts, tow-away alerts, time curfew, geofencing and sudden drop in fuel level.

2 Hydraulic functions to avoid unintended movements: JCB's unique 2GO system ensures that the hydraulic operation of the new JCB NXT 205 can only be started from locked position via two separate inputs, which avoids unintended machine operation.

3 Swing lock system enables the operator to lock the swing operations only, whenever required.

4 Anti-engine restart system & anti-over cranking system protect the starter motor from damage, thus ensuring longer starter motor life & higher uptime.

5 Hydraulic accumulator enables the operator to lower down the front attachment in case of any emergency without starting the engine.



Stay connected 24x7

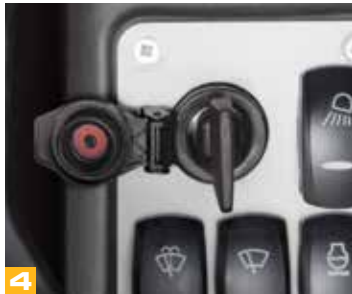



6 Anti-slip top covers provide safer grip to the personnel while working on the machine for maintenance.

7 Belly-guard installed in the lower frame and plates under the upper frame protect the major components from external damage, enabling the machine to work in tough underfoot conditions.

8 Engine start interlock is provided to ensure safe start of the machine, the engine can be started only when the servo isolator lock is ON.

9 Laminated RH & front top glass resist the damage against impact and provide comfortable & safe working environment to the operator.

10 Rigid hand rails for better support while climbing on the machine.



NXT LEVEL OF CARE

Uptime technology

JCB's advanced telematics solution - LiveLink and Tech Web are innovative connectivity solutions that facilitate 24x7 monitoring of machines. Through the use of big data these help in determining field issues and trends which result in better and faster service mobility. Moreover, inputs and analysis of this data help in offering solutions for preventive maintenance.

Machine Uptime

The JCB LiveLink mobile app has been updated with an SOS feature that allows for an instant alert to be sent to JCB dealerships - all at the simple press of a button. This real-time, convenient solution empowers customers to login their service requests instantly thus ensuring 24x7 continuity of operations for their business.

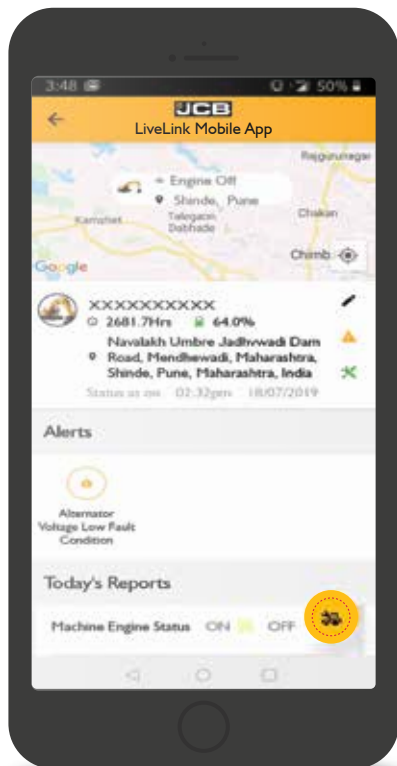



WE ARE CLOSER TO YOU

 **65+**
Dealers

 **700+**
Outlets

 **5,000+**
Trained service
engineers

 **5**
Parts warehouses

 **3,000+**
Mobile service
engineers

 **4**
Training centres

 **250+**
Service vans

 **24x7**
Support
12 Languages



Industry's finest customer support network

NXT LEVEL OF SERVICE & SUPPORT

HIGHLY SKILLED JCB ENGINEERS FOR EXCAVATORS

JCB's highly skilled engineers are there for you to maximise your profitability and reduce downtime. Our engineers are always there to serve you in a better way.



JCB trained and certified engineers



Best-in-class service and repairs



On-site customer training and support



SMART & DIGITAL SUPPORT

Smart Serve

Our service engineers are equipped with Smart Serve technology which enables JCB to send the closest engineer to the machine, ensuring maximum uptime.

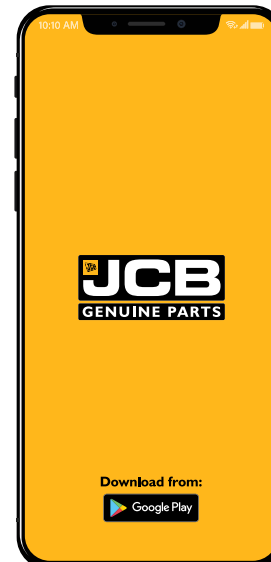

Assured parts supply

JCB in India have built a robust logistics and supply management chain across the country that facilitates the provision of parts for all machines in the shortest time. Customers can now get JCB genuine parts easily and conveniently through its mobile app.

NXT LEVEL OF CARE

GIVE YOUR MACHINE EXTENDED WARRANTY AND CARE.

- JCB Careplus is an extended warranty programme that comes into effect after the machine standard warranty expires.
- JCB Careplus can be purchased within the 1st year from the sale of the machine.
- The programme offers you peace of mind and saves your maintenance cost even after your machine standard warranty expires.



Extended
Warranty
Programme

BENEFITS OF JCB CAREPLUS



No limits
on number
of claims

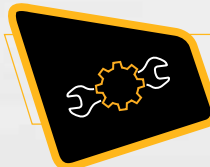

Preventive
maintenance
service*



Nationwide
coverage*



JCB skilled
manpower
support



Maximum
productivity



Maximum
uptime



Maximum
performance



Breakdown
cost protection

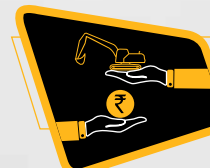

Better resale
value



*T&C Apply



NXT LEVEL OF CONNECT

NOW BE ASSURED OF YOUR JCB EXCAVATOR'S SERVICE, OPERATION AND SECURITY WITH THE ADVANCED TELEMATICS SYSTEM - LIVELINK*.

Security



In case of sudden drop in fuel level get an SMS/e-mail alert.



Alerts you via SMS/e-mail in case the machine is used outside the set hours.



Helps to locate your machine precisely on the map to display its current location.



Get SMS/e-mail alerts in case the machine moves out of the geofenced area.



Alerts you via SMS/e-mail in case the machine is being towed away even in engine off condition.

Operation & performance monitoring



Idle time monitoring helps in analysing the extent to which engine was idle. This can be used for better site management to minimise idle hours and save fuel consumption.



Machine usage can be monitored in detail including the hours worked in each mode.



Instantaneous fuel level monitoring.

Reports & alerts



Customised reports on performance, utilisation, fleet summary, landmark activity, machine hours and service status.



Easier fleet management.



Periodic reports - daily, weekly, monthly or as required.



Machine status and critical health alerts.

Proactive maintenance & usage



Maintenance reminders.



Alerts are provided in case any critical health parameter needs attention. Such alerts are displayed on the dashboard of the LiveLink website. These are sent by e-mail/ SMS.

Safety



Engine high rpm shut down report: Know the number of times the engine shuts down while working at high speeds.



Long engine idling report: Know the number of times the machine idles for a long time, minimising idle hours and saving fuel.



Critical health alerts on the parameter which needs immediate attention.

User friendly reports

Engine on-off time

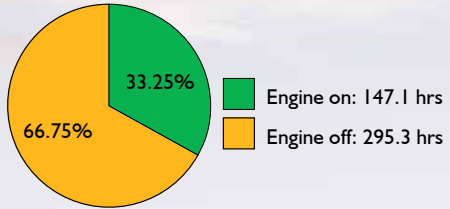

Working & idle time

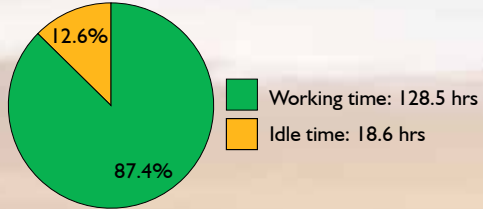

Power mode

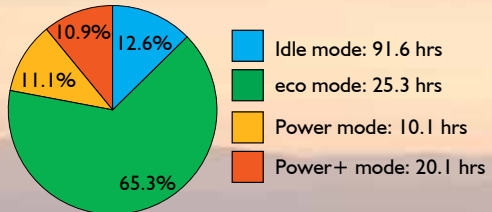

Stay connected 24x7



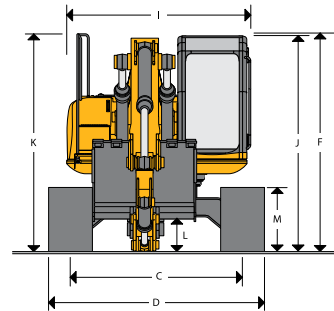
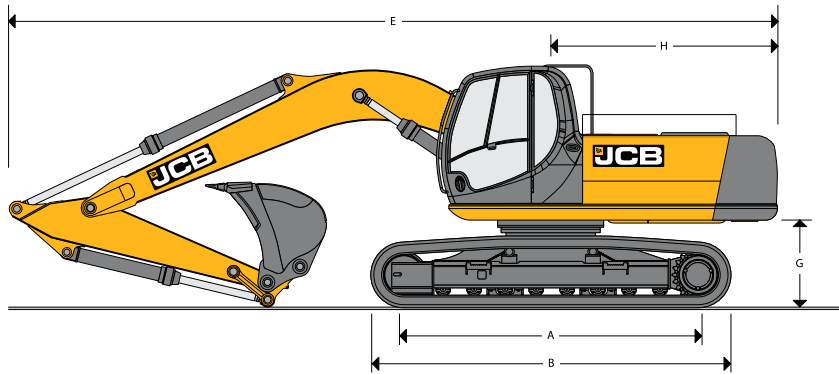

WEIGHT AND GROUND BEARING PRESSURE

Standard machine with bucket, operator, full capacity lubes and fuel

	JCB NXT 205	JCB NXT 205LC
Max operating weight	20,500 kg	21,250 kg
Ground bearing pressure	0.51 kg / sq cm	0.58 kg / sq cm

STATIC DIMENSIONS		JCB NXT 205 (Std track, 600 mm track shoe)		JCB NXT 205LC (LC track, 500 mm track shoe)	
		2.4 m arm	3 m arm	2.4 m arm	3 m arm
A	Track length on ground	3370	3370	3660	3660
B	Under carriage overall length	4170	4170	4460	4460
C	Track gauge	2200	2200	2390	2390
D	Width over tracks	2700	2700	2890	2890
E	Transport length with monoboom and arm	9634	9562	9634	9562
F	Transport height with monoboom and dipper	3122	3122	3122	3122
G	Counterweight clearance	1079	1079	1079	1079
H	Tailswing radius	2825	2825	2825	2825
I	Width of superstructure	2549	2549	2549	2549
J	Height over cab	3060	3060	3060	3060
L	Ground clearance	435	435	435	435
M	Track height	885	885	885	885

ENGINE

Model	: Cummins 6 BT 5.9C
Type	: Water cooled, 4 stroke, 6 cylinder in line direct injection, turbo-charged diesel.
Gross Power	: 140 HP @2000 rpm
Piston displacement	: 5.88 litres.
Max torque	: 571 N-m @ 1300 rpm
Bore X Stroke	: 102 mm X 120 mm
Starting system	: 24 volt.
Alternator	: 24V, 75 amp, heavy duty

SERVICE CAPACITIES

Fuel tank	343
Engine coolant	25.5
Engine oil	19
Hydraulic system	260
Hydraulic tank	120
Swing device	5
Travel device	2 x 5

CAB + CAB GUARD

Pressed steel construction with high strength rolled sections. Excellent all round visibility during digging, loading & positioning. Removable front lower glass and sliding rear window. Excellent ergonomic positioning of operating levers for reduced operator fatigue. Optional ducted AC unit for operator comfort. Windscreen wiper, FM radio with USB media player with speakers, mobile phone charging point & lockable stowage available. Rubber covered track pedal, water bottle & document holders provided. Optional cab guards for cab front & top available for protection against flying objects. Additional cab top lights for illumination.

EXCAVATOR BUCKET

All buckets are JCB type fully welded steel, with sealed, hardened steel pivot pins and replaceable wear parts.

Bucket	Toe plate width (mm)
0.9 cu.m (GP)	1180
0.9 cu.m (HD)	1222
1.02 cu.m (GP)	1320
0.8 cu.m (Rock)	1144

TRAVEL SPEED & TRACTIVE EFFORT

Travel speed	3.8 kmph
Tractive force	170 kN

WORKING RANGE

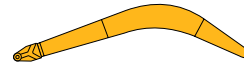

Boom length 5.7 m		Arm length	
Arm	Unit	2.40 m	3.00 m
A Maximum digging reach	mm	9398	9896
B Maximum digging reach (on ground)	mm	9210	9717
C Maximum digging depth	mm	6135	6732
D Maximum digging height	mm	9128	9224
E Maximum dumping height	mm	6359	6486
F Maximum vertical wall cut depth	mm	5567	6058
G Minimum swing radius	mm	3835	3798
Bucket rotation	deg.	177	177
Dipper tearout (ISO)	kgf	11832	9845
Bucket tearout (ISO)	kgf	13460	13460

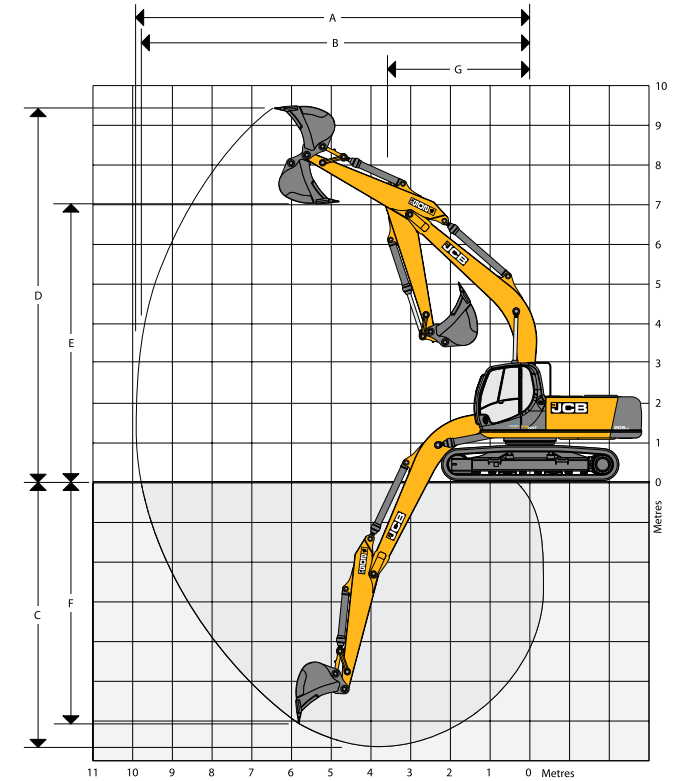

"All dimensions, weights, timings, features & measurements mentioned in the brochure could have variance. JCB reserves the right to change specifications without prior notice."

SWING SYSTEM

Swing motor	: Axial piston type.
Swing brake	: Hydraulic braking, electrically operated spring applied disc type parking brake.
Final drive	: Planetary reduction.
Swing torque	: 65.2 kNm
Swing gear	: Large diameter, internally toothed fully sealed grease bath lubricated.
Swing speed	: 13.0 RPM

HYDRAULIC SYSTEM

A variable flow load sensing system with flow on demand, variable power output and servo operated, multi-function open central control.

3 Work modes: eco, Power & Power+

Pumps

Main pumps	: 2 variable displacement axial piston type.
Maximum flow	: 2 x 220 L/min
Servo pump	: Gear type.
Maximum flow	: 20 L/min

Control valve

A combined four and five spool control valve with auxiliary service spool as standard. When required twin pump flow is combined to boom, dipper and bucket services for greater speed and efficiency.

Relief valve settings

Boom / Arm / Bucket	: 343 bar
Swing circuit	: 289 bar
Travel circuit	: 343 bar
Pilot control	: 40 bar
Main control valve	: 9 Spool

CONTROLS

Excavator : All servo lever operated to ISO control pattern
 Engine auto-idler : Reduces engine speed to low idle depending upon machine utilisation thus saving fuel.
 Tracks : Individually servo operated by foot pedal or hand lever
 Auxiliary : Via servo operated foot pedal.
 Horn : Operated via servo lever mounted button.

UNDERCARRIAGE

Construction: Standard/Long undercarriage fully welded. X-frame type with central belly guarding and sloping side members with dirt relief holes under top rollers.

	JCB NXT 205	JCB NXT 205LC
Track Shoe	600mm (standard)	500mm (standard)
Upper & lower rollers	Heat treated, sealed and lubricated.	Heat treated, sealed and lubricated.
Track adjustment	Sealed and lubricated, with spring enhanced recoil.	
No. of track guides	2 per side	2 per side
No. of lower rollers	7 Per side	8 Per side
No. of upper rollers	2 per side	2 per side
No. of track shoes	46 per side	49 per side

STANDARD EQUIPMENT

FM Radio and USB music player with speakers.
 auto-Idler
 Work lights: 2 nos. on booms and 1 no. on main frame
 Additional lights; 2 nos. on cab & 1 no. on counterweight
 Windscreen wiper
 Engine fan guard
 Undercarriage belly guarding
 Upper structure under covers
 Engine pre-cleaner
 Double element radial type air cleaner with wire mesh protection
 Heavy-duty alternator (75 amp)
 Cabin fan
 Suspension seat
 Cab floor mat
 Rubber covered track pedals
 Removable front lower cab glass
 Hammer pipe mounting brackets
 Tool Kit
 Handrail and non-slip walkways
 Radiator fly screen
 LiveLink

OPTIONAL EQUIPMENT

Fully ducted air conditioner unit
 Cabin guard (Front and Top)
 Rock breaker
 Rock breaker pipe work.
 General purpose buckets (0.9 cu.m, 1.02 cu.m)
 Heavy-duty buckets (0.8 cu.m, 0.9 cu.m)
 First aid kit
 Fire extinguisher
 Long reach attachment (15 m)
 Cab sun screen
 3 m arm
 Refuel pump



TRACK DRIVE

Type : Fully hydrostatic

Travel motors : Axial piston type, fully guarded within undercarriage frame.

Final drive : Planetary reduction, bolt-on sprockets

Service brake : Hydraulic counter balance valve to prevent over speeding on gradients.

Park brake : Disc type, spring applied, automatic hydraulic release.

Gradeability : 70% (35 deg.) continuous

Travel speed : 3.8 kmph

Tractive effort : 170 kN

EXCAVATOR END

Deep section design of boom & arm with cast ends & pivot bosses with braker pipe mounting provision.

FILTRATION SYSTEM

The hydraulic components are protected by the highest standard of filtration to ensure long hydraulic fluid life up to 5000 hrs (subject to SOS & recommended maintenance practices) and component life.

In tank : 150 micron, suction strainer

Main return line : 10 micron, fibre form element

Pilot line : 10 micron, paper element

Hydraulic hammer return : 5 micron, reinforced microform element.

Cooling : Cooling is provided via full return line air blast cooler with anti-block wavy cooling fins. Fly mesh provided to avoid clogging of radiator and cooler films.

LIFT CAPACITIES

Reach	3 m		4.5 m		6.0 m		7.5 m		Capacity at max. reach	
Load point height										

JCB NXT 205 LIFT CAPACITIES : Arm 2.4 m, Tracks : 49 Links, Track shoes : 500 mm, without bucket

Reach	3 m		4.5 m		6 m		7.5 m		Max. Reach		Max. Reach
Load point height	Kg	Kg	Kg	Kg	Kg	Kg	Kg	Kg	Kg	Kg	mm
7.5 m									5830*	5590	5533
6 m					5630*	4910			5580*	4020	6755
4.5 m			7130*	7130*	6110*	9770			5130*	3340	7486
3-0 m			9020*	6920	6940	4550	5030	3260	4670	3020	7876
1.5 m			10630	6490	6900	4340	4930	3170	4520	2910	7949
0 m			10670	6300	6740	4210	4860	3100	4650	2980	7741
-1.5 m	11210*	11210*	10640	6227	6700	4170			5140	3270	7218
-3.0 m	14070*	12470	10190	6360	6180	4240			6330	3990	6300
-4.5 m	10600*	10600*	7520*	6640					6930*	6140	4760

JCB NXT 205 LIFT CAPACITIES : A rm 3 m, Tracks : 49 Links, Track shoes : 500 mm, without bucket

Reach	3 m		4.5 m		6 m		7.5 m		Max. Reach		Max. Reach
Load point height	Kg	Kg	Kg	Kg	Kg	Kg	Kg	Kg	Kg	Kg	mm
7.5 m									4130*	4130	6226
6 m									3870*	3540	7332
4.5 m					5530*	4830	5156	3370	3840*	3010	8011
3-0 m	12490	12490	8140*	7060	6420	4590	5050	3260	3970	2730	8367
1.5 m			9960	6550	6910	4350	4920	3150	4110	2630	8444
0 m	6660	6660	10650	6260	6710	4170	4820	3050	4200	2670	8249
-1.5 m	11050*	11050*	10530	6170	6620	4090	4780	3020	4560	2890	7760
-3.0 m	15210*	12180	10590	6270	6650	4110			5410	3410	6916
-4.5 m	12430*	12430	8850*	6410					6850*	4760	5552

JS205 LIFT CAPACITIES : Arm 2.4 m, Tracks : 46 Links, Track-shoes : 600 mm, without bucket

Reach	3 m (9ft 10in)		4.5 m		6m		7.5 m		Max. Reach		Max. Reach
Load point height	Kg	Kg	Kg	Kg	Kg	Kg	Kg	Kg	Kg	Kg	mm
7.5 m									5248*	4855	5577
6 m					6046*	4313			4840*	3493	6782
4.5 m			7624*	6445	6484	4158	4514	2900	4511	2898	7504
3-0 m			9624*	5900	6226	3928	4427	2820	4099	2608	7876
1.5 m			9271	5466	5984	3711	4319	2721	3965	2500	7950
0 m			9037	5268	5827	3571	4247	2655	4072	2550	7735
-1.5 m	10531*	9950	9003	5239	5780	3530			4490	2799	7202
-3.0 m	14788*	10142	9117	5335	5870	3610			5527	3423	6273
-4.5 m			7952*	5629					7449*	5294	4711

Lift capacity front and rear

Lift capacity full circle

Notes:

• For lifting capacity including bucket, subtract total weight of bucket or bucket and quick hitch from above value • The above loads are in compliance with SAE and ISO standards i.e. 75% of minimum tipping load or 87% of hydraulic lift capacity, whichever is less. Lifting capacities marked * are based on hydraulic capacity.



ONE COMPANY, OVER 300 MACHINES.

Dealer's stamp:

JCB INDIA LIMITED 23/7 Mathura Road, Ballabgarh - 121 004 Haryana, India.
For more information SMS "JCB" to 56767 or call our toll free no. 1800-1037-386
Fax: 91 129 2309050 Website: www.jcb.com

Follow us: [f](#) [t](#) [v](#) [i](#) [i](#) /JCBIndiaLtd

©2009 JCB Sales. All rights reserved. No part of this publication may be reproduced, stored in a retrieval system, or transmitted in any form or by any other means, electronic, mechanical, photocopying or otherwise, without prior permission from JCB Sales. All references in this publication to operating weights, sizes, capacities and other performance measurements are provided for guidance only and may vary dependant upon the exact specification of machine. They should not therefore be relied upon in relation to suitability for a particular application. Guidance and advice should always be sought from your JCB Dealer. JCB reserves the right to change specifications without notice. Illustrations and specifications shown may include optional equipment and accessories. The JCB logo is a registered trademark of J C Bamford Excavators Ltd.

